



90-1214



90-1215

# Installation, Safety & Maintenance Manual

## Model 1750/1770

### INSTALLER – PLEASE NOTE!

1. **Installation must conform to all applicable codes.**
2. **For the 1750, a dedicated 15 Amp circuit is recommended but not required for proper operation of the dehumidifier.** If a dedicated circuit is not available, use a lightly loaded circuit. Do not use an extension cord.
3. **For the 1770, a dedicated 20 Amp circuit is required for proper operation of the dehumidifier.** If a dedicated circuit is not available, do not install unit. Dehumidifier must be plugged in directly to an outlet. Do not use an extension cord.
4. **For protection of the compressor, unit must be transported and installed in an upright position.** If the unit was shipped or stored on its side, a 24 hour settling period is required before running the unit.

### TABLE OF CONTENTS

Safety Instructions . . . . .	2	<b>Installations</b>		Float Switch . . . . .	12
Overview . . . . .	2	Central . . . . .	4	Dip Switch Definitions . . . . .	12
Specifications . . . . .	2	Localized . . . . .	6	System Checkout . . . . .	13
Location Notes . . . . .	2	Central/Zoned . . . . .	8	Troubleshooting . . . . .	14
Ducting . . . . .	3	Air Cycling . . . . .	10	Sequences of Operations . . . . .	Back Cover
Drain Line . . . . .	3				
Hanging . . . . .	3				

## SAFETY INSTRUCTIONS

### WARNING

- This product must be installed by a qualified heating and air conditioning contractor. Failure to do so could result in serious injury from electrical shock or damage to product.
- **120 volts may cause serious injury from electric shock.** Disconnect electrical power before starting installation. Leave power disconnected until installation is completed.
- **Sharp edges may cause serious injury from cuts.** Use care when cutting plenum openings and handling ductwork.
- **Unit weight and dropping may cause personal injury or equipment damage.** Handle with care.

### CAUTION

**Do not use solvents/cleaners on or near the circuit boards.**

## OVERVIEW

This Aprilaire Central Dehumidifier is designed specifically to control humidity inside the whole home as well as in crawlspaces and attics. This dehumidifier automatically and continually measures the true measure of moisture level, dew point. The unit operates to control humidity to the dryness set point that is either set on the unit or on the optional living space control.

A built-in, automatic air cycling feature can be utilized to activate the HVAC fan to cycle the air throughout the whole home for proper balance for comfort. See Air Cycling, page 10, for more details on this feature.

This dehumidifier also has a patented, built-in ventilation feature, which will allow fresh air to be brought into the home from the outside. In utilizing this feature, the dehumidifier will dehumidify the incoming air, if needed (based on dew point / dryness set point), as the outside air is first entering the home. The built-in ventilation feature is designed to be able to meet ASHRAE 62.2 Standard for Ventilation. See Ventilation, page 10, for more details on this feature.

## SPECIFICATIONS

**Dimensions:** 20<sup>3</sup>/<sub>4</sub>"W x 24"L x 20<sup>3</sup>/<sub>8</sub>"H (mounting feet fully engaged)  
20<sup>3</sup>/<sub>4</sub>"W x 24"L x 23<sup>5</sup>/<sub>8</sub>"H (mounting feet fully extended)

**Weight:** 1750 - 93 lbs. 1770 - 100 lbs

**Capacity:** 1750 - 90 pints per day @ 60%RH, 80°F  
1770 - 150 pints per day @ 60%RH, 80°F  
(ANSI/AHAM DH-1-2003 conditions)

**Power:** 1750 - 115 VAC, 8 Amps. 1770 - 115 VAC, 14 Amps.  
Unit is equipped with an 8 ft. grounded power cord.

**Design Airflow:** 1750 - 275 CFM @ 0.6 in. w.c.  
1770 - 500 CFM @ 0.6 in. w.c.

**Filter:** MERV 8 Filter

**Cabinet Insulation:** 1" foil faced EPS insulation

**Inlet Air Operating Conditions:** 40°F to 105°F

**Ambient Air Operating Conditions:** 40°F to 150°F

## LOCATION NOTES

In coastal areas, due to high concentrations of salt and other corrosive material present in the air, it is recommended to use a Model 70 Living Space Control. Please note the dehumidifier is not meant to be used in pool applications.

Note the following installation requirements:

REQUIREMENT	APPLICATION LOCATION			
	ATTIC	GARAGE	BASEMENT	CRAWLSPACE
All ductwork must be insulated and sealed	✓	✓		✓
Drain pan with overflow protection should be placed under the unit to prevent water damage in the event of a drain failure	✓	✓		
Codensate line should be insulated to prevent external condensation on the line	✓	✓		✓
Ensure the unit does not operate in conditions below 40F or above 150F	✓	✓	✓	✓

## DUCTING

The Aprilaire Dehumidifier is supplied with two 8" round collars. These are packaged with a drain trap inside the unit behind the filter access panel. Secure the collars with Four (4) 1-inch sheet metal screws (not included). UL approved 8" diameter, insulated flexible duct is recommended for all connections. Rigid metal duct may also be used. The duct should be capable of handling at least 2" w.c. pressure. All joints and seams must be sealed.

Design airflow for the 1750 is 275 CFM @ 0.6" w.c., for the 1770 it is 500 CFM @ 0.8" w.c. This is equivalent to approximately 70 ft. for the 1750 or 100 ft for the 1770 of 8" duct on the inlet and outlet side of the dehumidifier. Elbows, turns and the static pressure of the HVAC equipment will affect the airflow through the dehumidifier.

- For optimal moisture removal, airflow should be at or above 275 CFM for the 1750, 500 CFM for the 1770.
- The total static pressure across the 1750 must not exceed 0.8" w.c., 1.5" w.c. for the 1770. Check all pressures with the HVAC fan on.
- The outlet from the dehumidifier to the HVAC supply duct must be located at least 6" downstream of the cooling coil to prevent air from pulling moisture from the coil.
- If connected to HVAC ductwork, the dehumidifier inlet must be located at least 6" upstream of the HVAC system air cleaner. This will prevent any trapped particulates from being drawn into the dehumidifier.
- If UV Germicidal lamps are installed in the HVAC system, use appropriate methods to protect the flexible duct from the UV light.
- To further reduce any sound that may be created by air movement, install at least 5 feet of acoustical flexible duct on the outlet and inlet of the dehumidifier.

## DRAIN LINE

The included drain trap must be installed to the dehumidifier. Use PVC primer and cement to connect the trap to the drain outlet on the dehumidifier. The drain outlet is located near the On/Off toggle switch. **Note orientation of trap prior to cementing.** The high side of the

trap mates with the dehumidifier. The adjustable legs on the dehumidifier must be disengaged approximately  $1\frac{7}{8}$ " to accommodate the trap. Loosen nuts before adjusting. Complete the assembly by piping the trap to a drain. The trap must be primed with water prior to start-up.

If the dehumidifier is installed in an attic or in an area where flooding is a potential problem, it should be installed in a secondary drain pan with a float switch. See page 12 for float switch wiring.

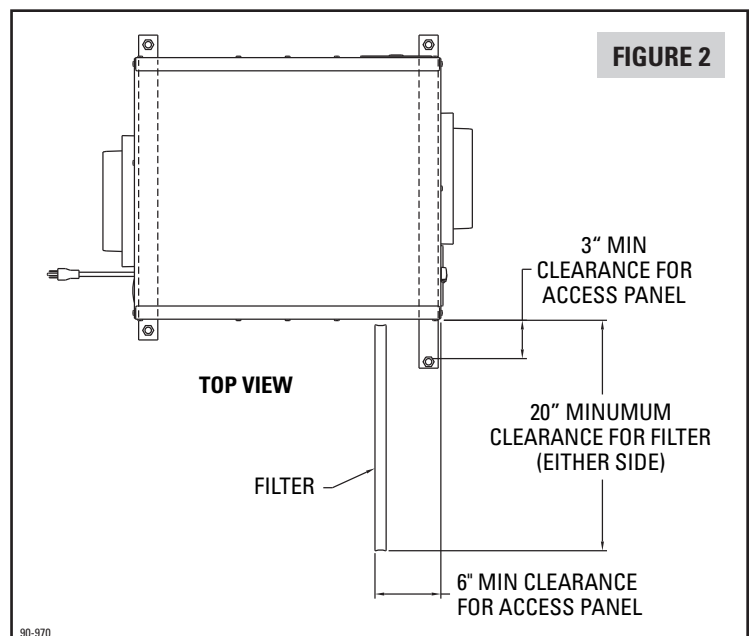
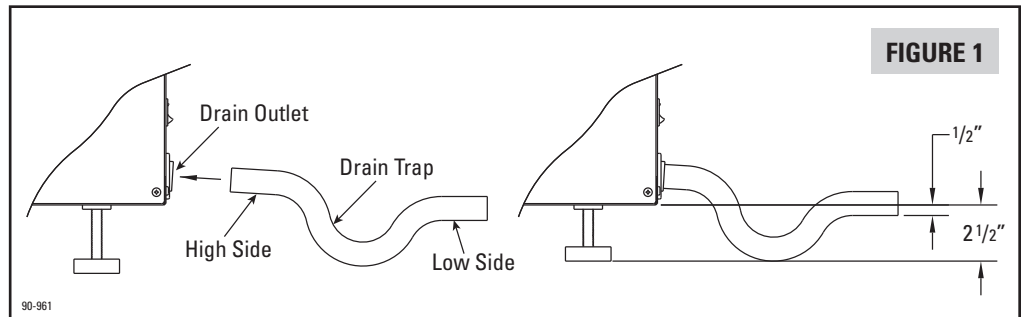

## HANGING

If hanging the unit, use two unistruts to support the base on the outside edges of the feet locations. There must be at least 20" of clearance in front of one of the filter access doors to allow removal of the filter.

## CENTRAL INSTALLATION AND OPERATION

This installation is used when the HVAC equipment conditions the whole home or the area where dehumidification is needed. Using an Aprilaire Central Dehumidifier in this application, in conjunction with the HVAC system, is the optimum solution for total, year-round humidity control.

This installation is typically in attic or basement locations within the home. As shown in Figure 3 below, air is pulled from the return duct, dehumidified and returned to the supply duct.

### REQUIRED COMPONENTS

1 – Backflow Damper  
 Duct Work  
 Thermostat Wire

### OPTIONAL COMPONENTS

6506 Ventilation Damper  
 24 VAC Transformer (10 VA minimum) for Ventilation Damper  
 8052 Outdoor Temperature Sensor  
 Float Switch  
 Model 70 Living Space Control

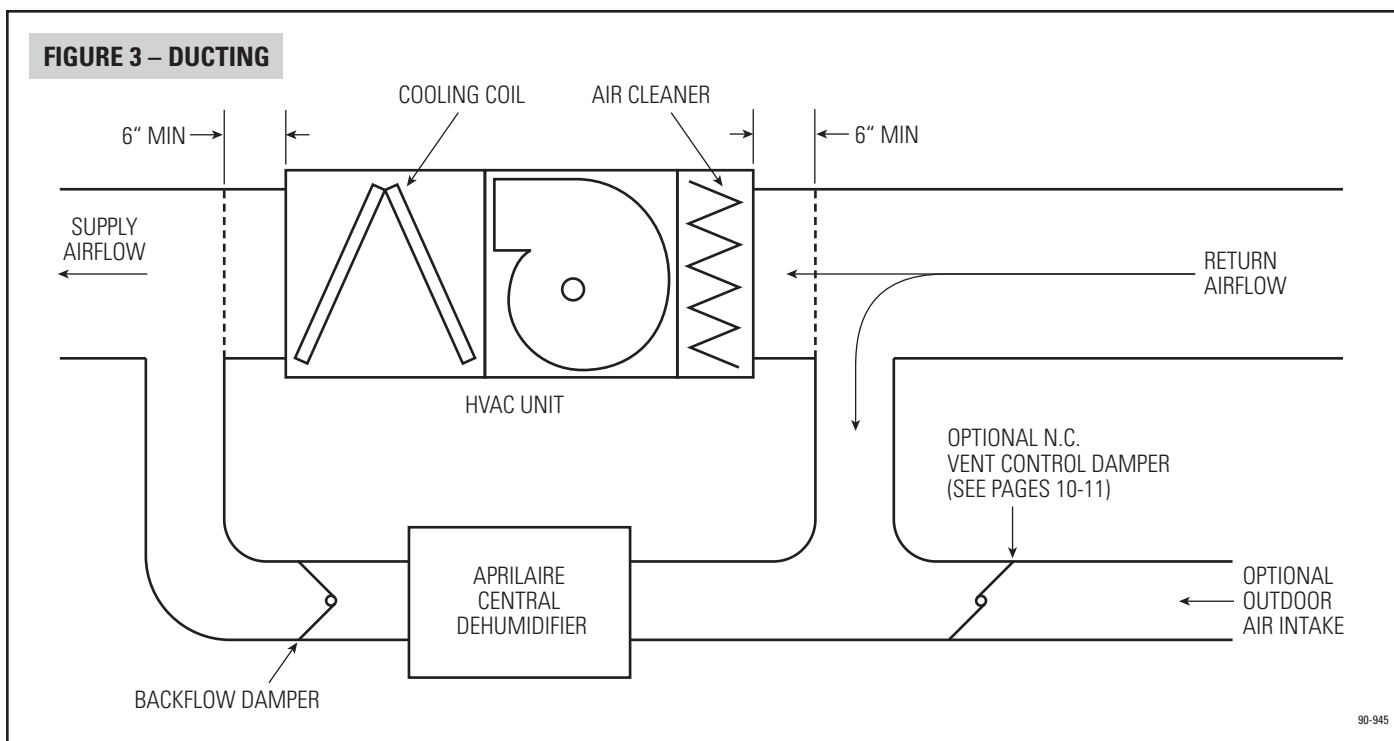

# CENTRAL INSTALLATION AND OPERATION (CONTINUED)

**FIGURE 4 – WIRING**

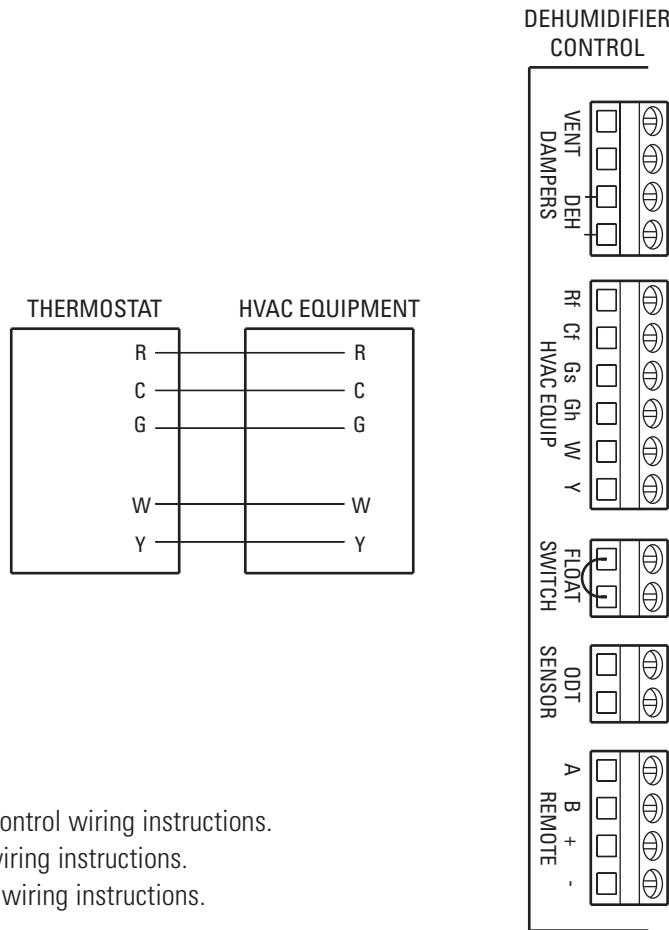

See page 10 for ventilation control wiring instructions.  
 See page 10 for air cycling wiring instructions.  
 See page 11 for float switch wiring instructions.

90-962

**FIGURE 5 – SETTINGS**

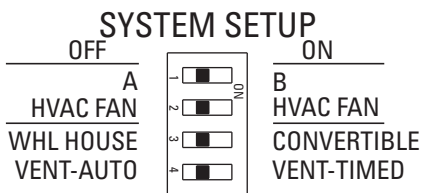

**CYCLE PERIOD**

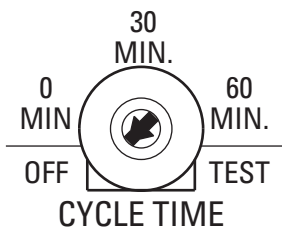
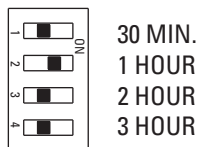

Standard	Air Cycling	Ventilation
OFF	OFF	OFF
See pages 10-11	See pages 10-11	See pages 10-11
OFF	OFF	OFF
OFF	ON	OFF

Standard	Air Cycling	Ventilation
OFF	See pages 10-11	See pages 10-11
ON	See pages 10-11	See pages 10-11
OFF	See pages 10-11	See pages 10-11
OFF	See pages 10-11	See pages 10-11

Standard	Air Cycling	Ventilation
OFF	See pages 10-11	See pages 10-11

90-963

## LOCALIZED INSTALLATION AND OPERATION

In this configuration, the central dehumidifier will pull air specifically from a local area, and is typically not ducted to the HVAC equipment for the whole home conditioning and humidity control. Rather, this application will control humidity in a specific area, typically a basement or crawlspace.

### REQUIRED COMPONENTS

Power Supply Circuit  
 Drain Trap (included)

### OPTIONAL COMPONENTS

Duct Work  
 24 VAC Transformer (10 VA minimum) for Ventilation Damper  
 Thermostat Wire  
 6506 Ventilation Damper  
 8052 Outdoor Temperature Sensor  
 Grilles  
 Normally Closed Condensate Overflow Safety Switch  
 Model 70 Living Space Control

**FIGURE 6 – DUCTING**

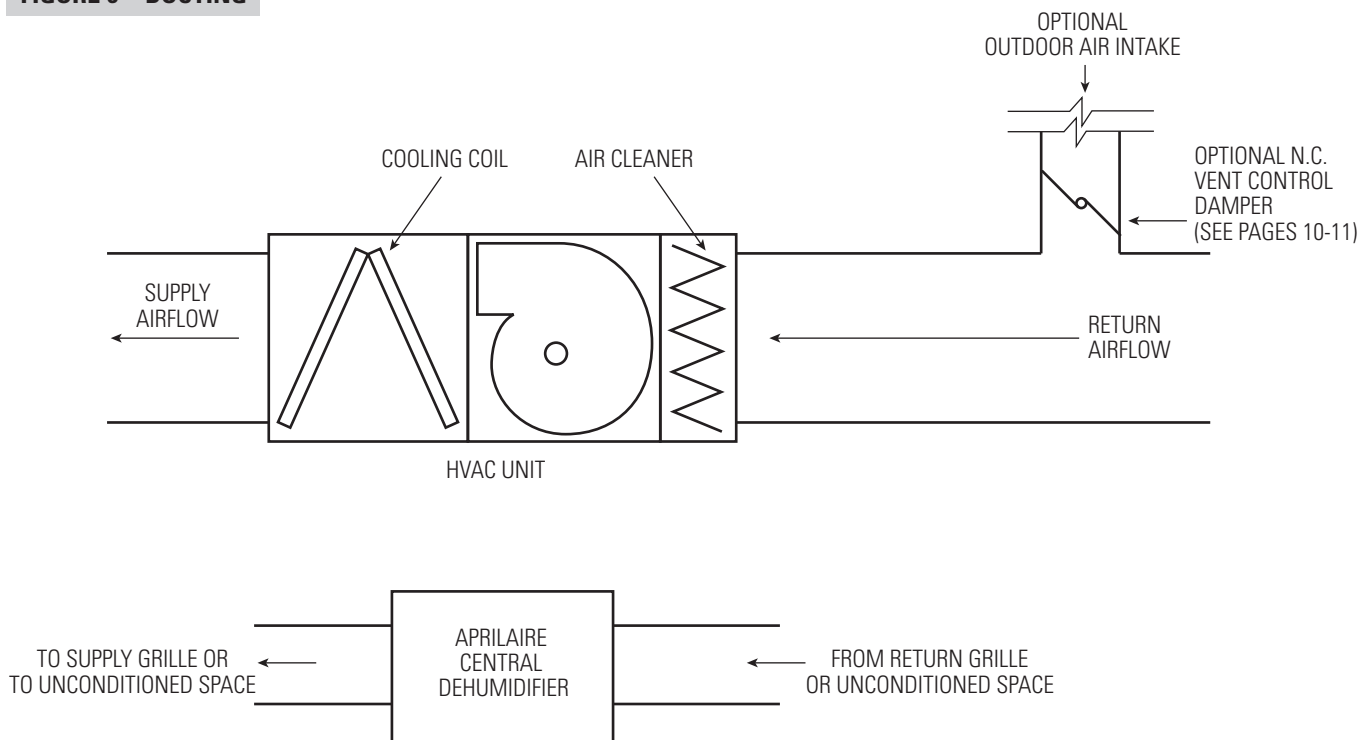

90-946

# LOCALIZED INSTALLATION AND OPERATION (CONTINUED)

**FIGURE 7 – WIRING**

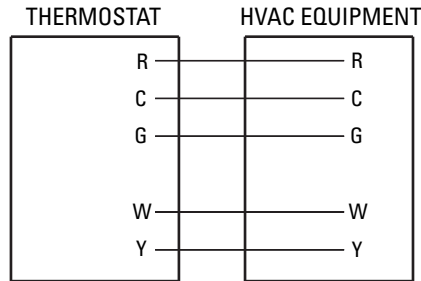

**DEHUMIDIFIER CONTROL**

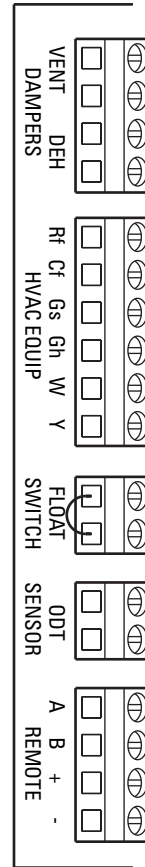

See page 10 for ventilation control wiring instructions.  
 See page 10 for air cycling wiring instructions.  
 See page 11 for float switch wiring instructions.

90-964

**FIGURE 8 – SETTINGS**

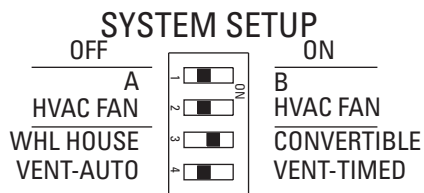

**CYCLE PERIOD**

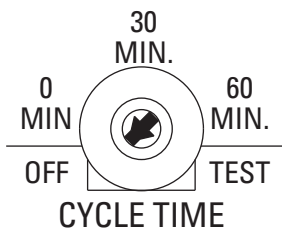
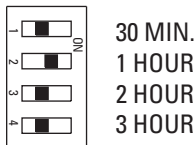

Standard	Air Cycling	Ventilation
OFF	OFF	OFF
See pages 10-11	See pages 10-11	See pages 10-11
ON	ON	ON
OFF	ON	OFF

Standard	Air Cycling	Ventilation
OFF	See pages 10-11	See pages 10-11
ON	See pages 10-11	See pages 10-11
OFF	See pages 10-11	See pages 10-11
OFF	See pages 10-11	See pages 10-11

Standard	Air Cycling	Ventilation
OFF	See pages 10-11	See pages 10-11

90-965

## CENTRAL / ZONED (CONVERTIBLE) INSTALLATION AND OPERATION

The Aprilaire central dehumidifier can be utilized not only for whole home humidity and comfort control, but also for addressing specific zones or spaces that are high priority for humidity control. In this application, the central dehumidifier will control humidity in the specific zone independently, as the higher priority, and then switch to the whole home when the HVAC equipment is on/operating. **Do Not use a Model 70 Living Space Control in this application.**

### REQUIRED COMPONENTS

2 – 6508 Normally Closed Power Open Damper  
 2 – 6608 Normally Open Power Closed Damper  
 Duct Work  
 24 VAC Transformer (40 VA minimum)  
 Thermostat Wire

### OPTIONAL COMPONENTS

6506 Ventilation Damper  
 24 VAC Transformer (10 VA minimum) for Ventilation Damper  
 8052 Outdoor Temperature Sensor  
 Normally Closed Condensate Overflow Safety Switch

**NOTE:** 1. 4522 Basement Kit includes 2 – 6508 N.C. Dampers, 2 – 6608 N.O. Dampers and a 24 VAC Transformer.  
 2. Running Constant fan on will prevent proper function in this mode.

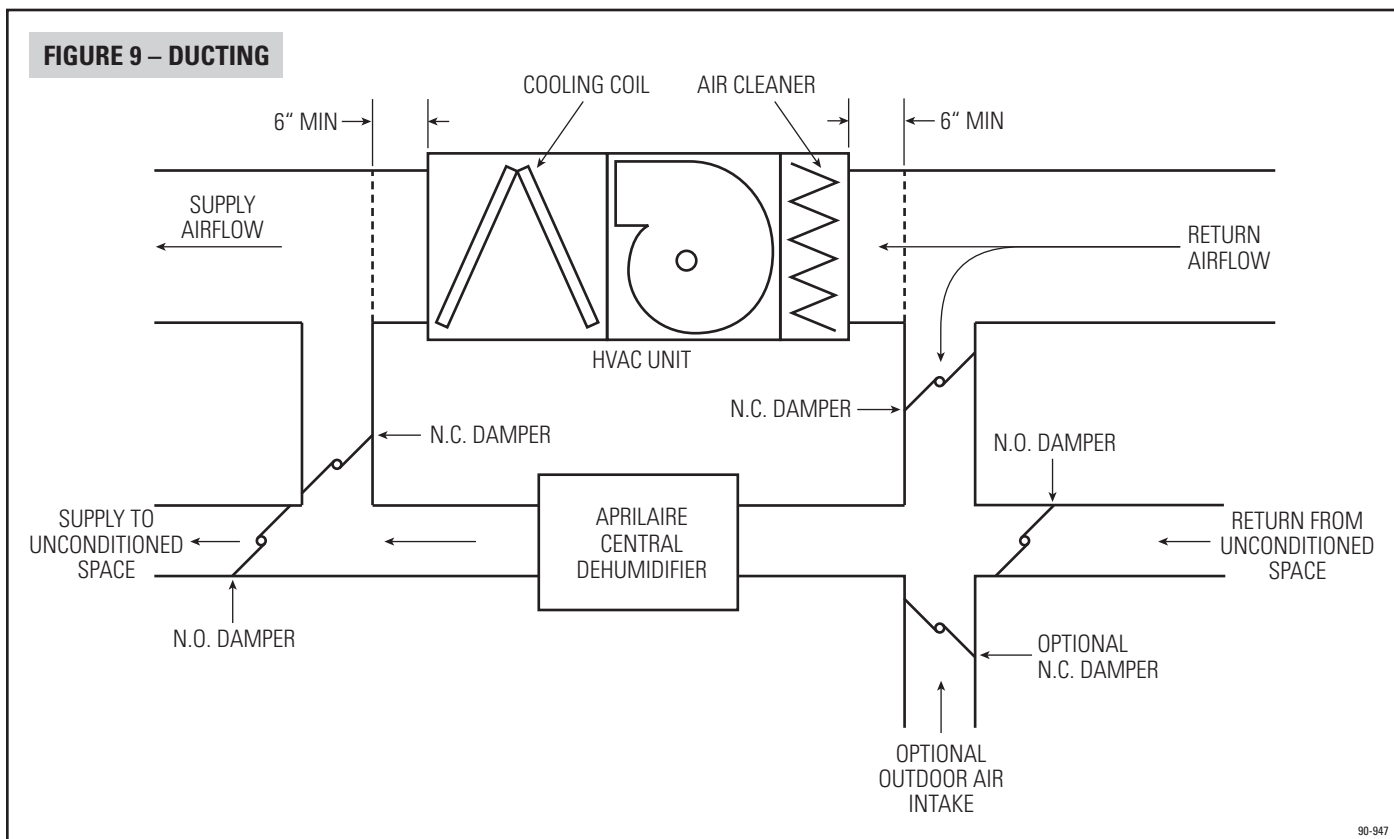



# CENTRAL / ZONED (CONVERTIBLE) INSTALLATION AND OPERATION (CONTINUED)

**FIGURE 10 – WIRING**

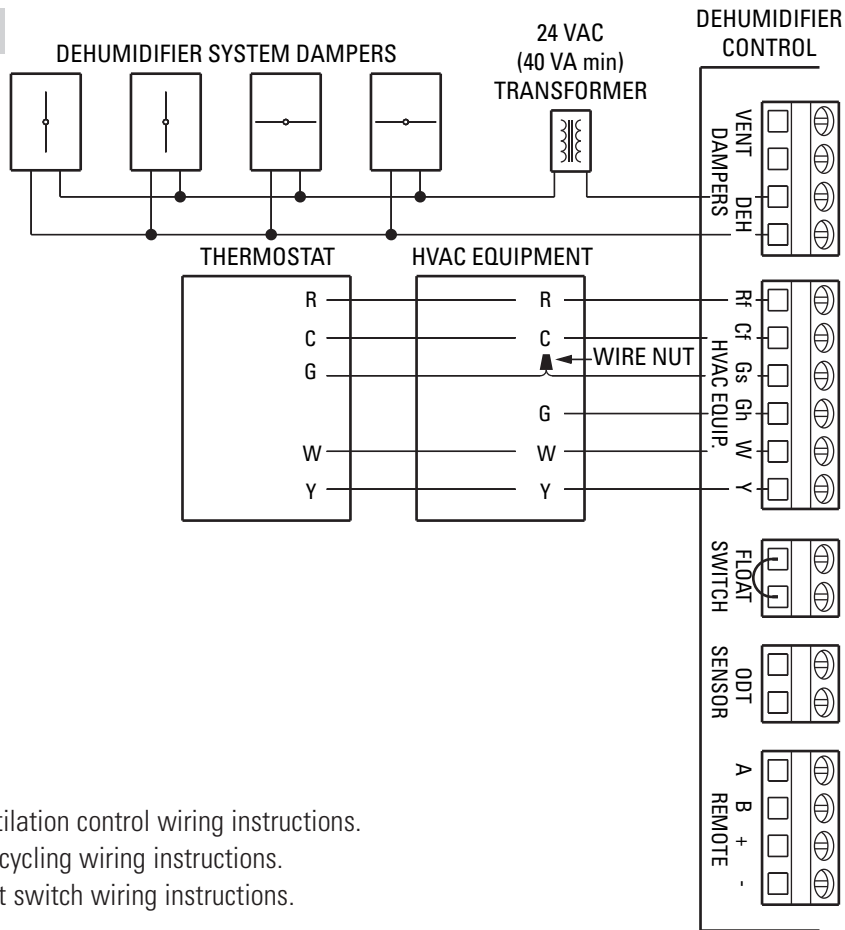

See page 10 for ventilation control wiring instructions.  
 See page 10 for fan cycling wiring instructions.  
 See page 11 for float switch wiring instructions.

90-966

**FIGURE 11 – SETTINGS**

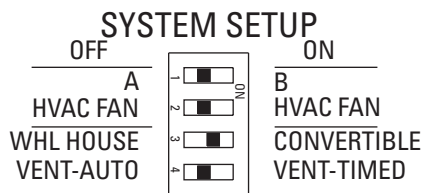

**CYCLE PERIOD**

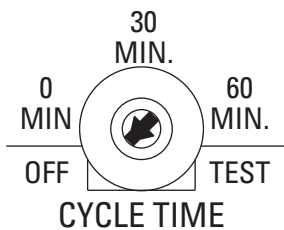
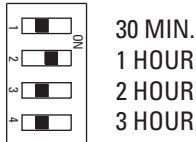

Standard	Air Cycling	Ventilation
OFF	OFF	OFF
OFF	OFF	OFF
ON	ON	ON
OFF	ON	OFF

Standard	Air Cycling	Ventilation
OFF	See pages 10-11	See pages 10-11
ON	See pages 10-11	See pages 10-11
OFF	See pages 10-11	See pages 10-11
OFF	See pages 10-11	See pages 10-11

Standard	Air Cycling	Ventilation
OFF	See pages 10-11	See pages 10-11

90-965

## VENTILATION / AIR CYCLING SETTINGS

The Aprilaire Dehumidifier has the option to monitor HVAC heating, cooling and fan calls to assure the HVAC fan has operated a predetermined amount of time each 1/2, 1, 2 or 3 hours. The dehumidifier can also open a normally closed damper in an outdoor air intake to ventilate during this predetermined amount of time. This feature will function even if the dehumidifier is turned off at the dehumidifier or Model 70 Occupied Space Control. The only way to disable this feature is by turning the Cycle Time setting to OFF or turning power off at the On/Off switch.

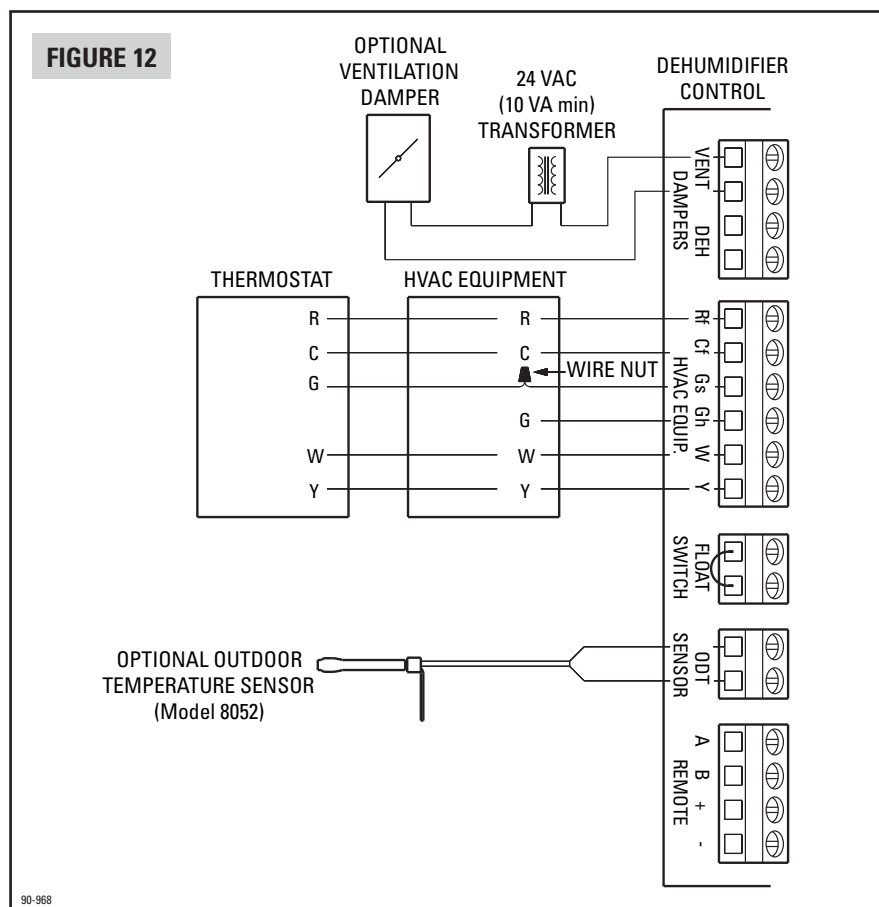

### AIR CYCLING

- Set the 1/2, 1, 2 or 3 hour period by setting the CYCLE PERIOD dip switches (**Figure 13**) to determine how often the dehumidifier should look to cycle the HVAC fan. The factory default setting is 1 hour.
- The CYCLE TIME dial determines how long during every Cycle Period the HVAC fan should operate. Adjust the dial from OFF to between 1 and 60 minutes. This will give you HVAC fan operation from 1 to 60 minutes every 1/2, 1, 2 or 3 hours. A call for heat, cooling or fan from the HVAC equipment will often satisfy the run time requirement. If not, the dehumidifier will turn on the HVAC fan to assure that the Cycle Time is met. **For example: If the building requires air cycling of 20 minutes every two hours set the CYCLE PERIOD Dip Switch for 2 hours to ON, turn OFF the 1 HOUR Dip Switch and rotate the CYCLE TIME to 20 minutes. If the HVAC equipment has only run for 10 minutes, the dehumidifier will turn on the HVAC fan for 10 minutes at the end of the 2 hours to assure the fan cycling time.**

**FIGURE 13** (shown set to 1 hour)

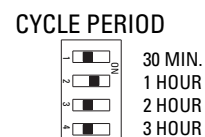

**FIGURE 14** (shown set to 30 minutes)

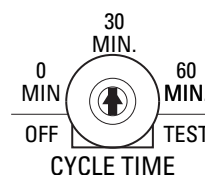

### OUTSIDE AIR VENTILATION

- If using the Ventilation Damper, determine if the ventilation should be restricted based on outdoor temperature. Set the VENT-AUTO / VENT-TIMED dip switch to VENT-AUTO (see **Figure 15**) to prevent opening the ventilation damper if the outdoor air is above 100°F, below 0°F or except with a heat call between 20°F and 0°F. In the VENT-TIMED setting the ventilation damper is activated regardless of outdoor conditions. **Note:** The Outdoor Temperature Sensor (Model 8052) must be installed for this to work.

**FIGURE 15**

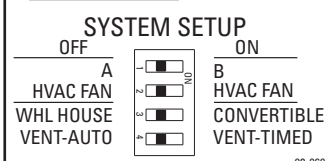

## VENTILATION / AIR CYCLING SETTINGS (CONTINUED)

B. This installed option allows outside air to be combined with the fan cycling feature from the dehumidifier, provided the outside air temperature is in the acceptable range (0-100°F). This will allow the homeowner to receive the proper ventilation year round.

**Note:** The dehumidifier can control the HVAC fan to provide fan cycling, regardless of whether or not an outdoor ventilation duct is installed.

- An Aprilaire® Normally-Closed Damper (Model 6506) should be installed in the outside air intake. It should be wired to the terminals labeled “VENT DAMPER” on the dehumidifier control board. Follow all installation instructions supplied with the damper. Refer to each installation for ducting.
- The Outdoor Temperature Sensor (Model 8052) should be installed outside in a shaded location (**Figure 16**) or in an outside air intake duct, but no more than 3 feet from the outside wall (**Figure 17**).
- The Outdoor Temperature Sensor is not affected by wire length. However, do not route the wire alongside wires carrying high voltage (115 VAC or greater), as interference may occur.
- Connect the wires from the sensor to the terminals labeled “ODT SENSOR” on the dehumidifier. See **Figure 12** for terminal locations.

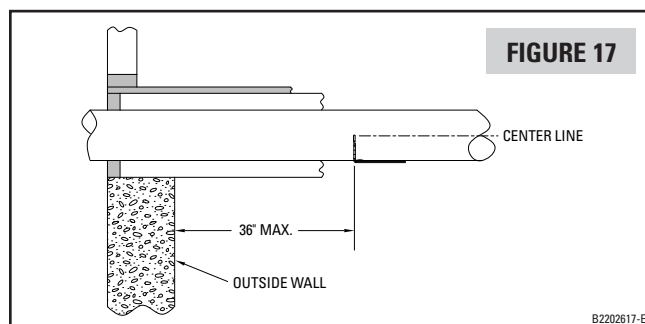
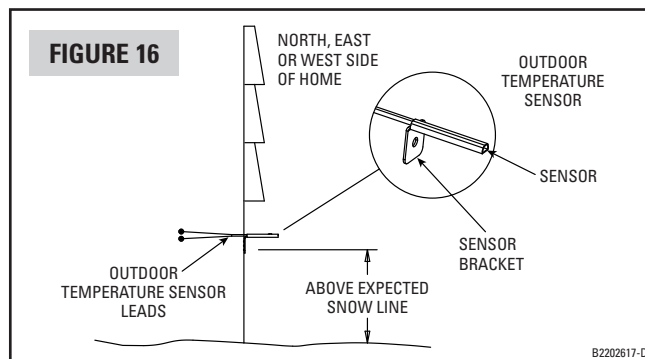

### STEP 1: CALCULATE THE VENTILATION REQUIREMENT

A. The MINIMUM ventilation requirement is calculated using ASHRAE 62.2-2004.

$$\text{ASHRAE Airflow In CFM} = [\text{House Area in Sq Ft} \times 0.01] + [\text{No. Bedrooms} + 1 \times 7.5]$$

Use the Number of Bedrooms (Plus 1) or the Number of Occupants, Whichever Is Larger

B. **Table 1** shows calculated airflow values at the nearest 5 cfm.

HOUSE SQ FT	TABLE 1 – Minimum CFM Per Number Bedrooms				
	2	3	4	5	6
1000	35	40	50	---	---
1500	40	45	55	60	70
2000	45	50	60	65	75
2500	50	55	65	70	80
3000	55	60	70	75	85
3500	---	---	75	80	90

## STEP 2: DETERMINE THE FRESH AIR DELIVERY RATE

- A. Measure the negative static pressure of the return system and consult **Table 2** below for approximate inlet airflow. An airflow measuring device (Nailor-Hart, etc.) will give the airflow exactly.
- B. For the table below, the flex duct is laid loose with 2 wide 90° bends, and the damper is fully open. For the rigid pipe, the values are based on two 90° elbows, and the damper is fully open. For both cases the air intake is through a metal vent hood with a bird screen. Adjust airflow accordingly for variations.

**TABLE 2 – AIRFLOW DELIVERY VS NEGATIVE STATIC PRESSURE AS MEASURED FOR RETURN DUCT OR PLENUM (IN WC)**

DUCT LENGTH	0.05		0.10		0.15		0.20		0.25		0.30	
	FLEX	PIPE	FLEX	PIPE	FLEX	PIPE	FLEX	PIPE	FLEX	PIPE	FLEX	PIPE
10 FT	60	65	85	90	105	110	120	125	135	140	150	160
20 FT	55	60	80	85	100	105	115	120	130	135	140	150
30 FT	50	55	75	80	95	100	110	115	125	130	130	140

## STEP 3: DETERMINE CYCLE TIME

- A. The Cycle Period determines how often the dehumidifier should look to ventilate. This is variable from 30 minutes to 3 hours (see **Figure 13**). Once the ventilation requirement is met, ventilation will not occur until the start of the next Cycle Period.
- B. The CYCLE TIME dial determines how long during every Cycle Period the damper will open and ventilation will occur. The dial can be adjusted from OFF to between 1 to 60 minutes (see **Figure 14**). This will give outdoor air ventilation and HVAC fan operation from 1 to 60 minutes every Cycle Period.
- C. Refer to **Table 3** to determine the Cycle Time setting based on airflow delivered and airflow required. The values listed in the table are for a 1 hour Cycle Period. For a 2 hour Cycle Period, the Cycle Time would be set to twice the value (if in the white area of the table). The values in the black portion of the table cannot be set due to the 60 minute Cycle Time limit.

**FIGURE 13** (shown set to 1 hour)

### CYCLE PERIOD

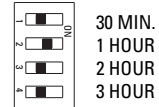

90-783C

**FIGURE 14** (shown set to 30 minutes)

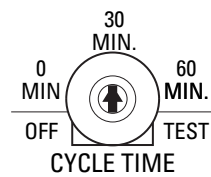

90-783C

**TABLE 3**

Airflow Required >>	20	30	40	50	60	70	80	90	100
Airflow Delivered	KNOB SETTINGS (in minutes) FOR AIRFLOW DELIVERED vs AIRFLOW REQUIRED (1 HR CYCLE)								
60	20	30	40	50	60	70	80	90	100
80	15	25	30	40	45	55	60	70	75
100	15	20	25	30	35	40	50	55	60
120	10	15	20	25	30	35	40	45	50
140	10	15	15	20	25	30	35	40	45
160	10	10	15	20	25	25	30	35	40

## FLOAT SWITCH

If the dehumidifier is installed in an attic or another location requiring leak protection, the unit should be placed in a drain pan with a normally closed condensate overflow safety switch (also known as a float switch). The float switch should be wired to the float switch terminals on the dehumidifier control board. See **Figure 18**. Remove the jumper at the float switch terminals. The compressor is disabled when the float switch is open. The dehumidifier will continue to ventilate when the float switch is open.

**FIGURE 18**

LOW VOLTAGE NORMALLY CLOSED FLOAT SWITCH

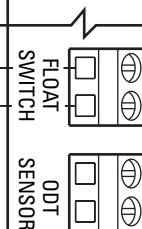
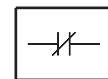

90-968A

## DIP SWITCH DEFINITIONS

### A-B (SYSTEM SETUP SWITCH #1):

Reserved for future use.

### HVAC FAN – OFF/ON (SYSTEM SETUP SWITCH #2):

Determines if the HVAC fan activates during a call for dehumidification.

**HVAC FAN-OFF** position. The dehumidifier will not activate the HVAC fan during a call for dehumidification; it will however activate the HVAC fan for air cycling and ventilation.

**HVAC FAN-ON** position. The dehumidifier will activate the HVAC fan during a call for dehumidification as well as for air cycling and ventilation.

Default is **HVAC FAN-OFF**.

### WHL HOUSE / CONVERTIBLE (SYSTEM SETUP SWITCH #3):

Determines when the dampers are powered open or closed.

**CONVERTIBLE** position. This is used for zoned dehumidification. The damper (DEH) terminals are actuated when the HVAC equipment is making a call for heat, cool or fan and the dehumidifier is making an internal blower call for air sampling or dehumidification.

**WHL HOUSE** position. This is used for central dehumidification. The damper (DEH) terminals are actuated any time the dehumidifier is making an internal blower call for air sampling or dehumidification.

The default position is **WHL HOUSE**.

### VENT-AUTO / VENT-TIMED (SYSTEM SETUP SWITCH #4):

Determines if ventilation is restricted based on outdoor temperature.

**VENT-AUTO** position. The dehumidifier will measure the outdoor temperature (through sensor, part # 8052) to determine if the ventilation damper will open. If the outside temperature is above 100°F or below 0°F the dehumidifier will not actuate the ventilation damper terminals (VENT DAMPER). If the outside temperature is between 0°F - 20°F, the dehumidifier will only actuate the ventilation damper terminals (VENT DAMPER) when the HVAC system is making a call for heat. The dehumidifier will energize the HVAC fan whether or not the ventilation damper opens.

**VENT-TIMED** position. The dehumidifier will actuate the ventilation damper terminals (VENT DAMPER) regardless of the outdoor temperature.

The default position is **VENT-AUTO**.

## SYSTEM CHECKOUT

1. Check the wiring to the HVAC equipment.
2. Rotate the main control knob clockwise to the "TEST" position.
3. If all is set up properly, the dehumidifier blower will turn on. The compressor will turn on after the dehumidifier blower has run for 3 minutes. After 1 minute the dehumidifier blower and compressor will shut off ("TEST" mode only).
4. If the dehumidifier blower does not activate in TEST mode, refer to the Troubleshooting Guide.
5. For ventilation (optional) test, be sure that 24 VAC is applied in series with the Aprilaire® Normally-Closed Damper (Model 6506) and connected to the "VENT DAMPER" terminals on the dehumidifier control.
6. Rotate the "CYCLE TIME" potentiometer clockwise to the "TEST" position.
7. If all is set up properly, the HVAC blower will turn on and the ventilation damper will open. Both should be audible to the installer. The HVAC blower will remain on and the ventilation damper will remain open for 1 minute or until the dial is turned from the "TEST" position, whichever happens first. **DO NOT** leave the CYCLE TIME in TEST.
8. If the optional ventilation damper or HVAC blower does not activate in TEST mode, refer to the Troubleshooting Guide.

# TROUBLESHOOTING GUIDE

## LED CODES

### Green LED

Activity	Status
ON Solid	Compressor ON
Blinking 1 second on, 1 second off	Sampling
Blinking 1/2 second ON, 1/2 second OFF	Defrosting

### Red LED

Activity	Status
1 Blink every 5 seconds	The RH sensor is having problems
2 Blink every 5 seconds	The temperature sensor is opened or shorted
3 Blink every 5 seconds	The Model 70 fails to respond after 3 consecutive attempts
4 Blink every 5 seconds	The refrigerant charge has been detected as low
5 Blink every 5 seconds	The temperature sensor is out of the operating range
6 Blink every 5 seconds	The frost sensor is opened or shorted
7 Blink every 5 seconds	The float switch has opened

### Test Mode

At the end of test mode (3 minutes of DEH Fan + 1 minute of Compressor ON & DEH Fan), the Red and Green LEDs will turn ON and OFF alternately until the knob has been turned away from "TEST".

## SYMPTOM

## TROUBLESHOOTING PROCEDURE / POSSIBLE REASON

Dehumidifier Blower is running, but no airflow.

- Normally Open Damper was used instead of Normally Closed Damper in backflow. Damper needs to be switched.
- Total HVAC system static is higher than 0.8" w.c.

Dehumidifier is producing hot air.

- Reheat of outgoing air will cause a temperature increase across the dehumidifier, which is normal.
- Unit will possibly run continuously initially. After unit has "dried" home, dehumidifier will cycle, reducing load.

Dehumidifier not adequately dehumidifying.

- Unit will need time to "dry" materials in home before effectively changing RH.
- Too little airflow through dehumidifier.
- Total HVAC system static is higher than 0.8" w.c.
- Compressor is not turning on.
- System undercharged.

Dehumidifier is not draining properly.

- Check drain trap to be sure it is clear.
- Check drain line for continuous slope.
- Confirm trap is properly installed and primed.

HVAC fan does not turn on when CYCLE TIME dial is in "TEST" mode.

- Make sure there is power to the HVAC equipment.
- Check the wiring diagram for the R, C, W, Y, GH, and GS at the HVAC equipment, thermostat, and the dehumidifier.
- Make sure the sensor is connected to the Outdoor Temperature Sensor terminals or the System Setup block is set to "TIMED" mode.
- Check the voltage across the R and C terminals at the dehumidifier. Voltage should be 18 VAC minimum - 30 VAC maximum.
- In "TEST" Mode, the HVAC fan will activate for 4 minutes, DO NOT LEAVE IN TEST MODE AS DEHUMIDIFIER WILL NOT OPERATE.

## TROUBLESHOOTING GUIDE (CONTINUED)

### SYMPTOM

### TROUBLESHOOTING PROCEDURE / POSSIBLE REASON

The dehumidifier damper does not open in "TEST" Mode.

- Follow all of the system checkout procedures.
- Check the wiring diagram for the damper and 24 VAC transformers.

Fan cycling operates continuously after the dial is taken off "TEST" mode.

- If the HVAC equipment is making a Heat or Cool call, or the fan is in Continuous Operation, fan cycling will remain on until the requirement set by the CYCLE PERIOD dip switch and knob is met.
- If the interval is set at 1 HOUR and the Cycle Time is set at 60 minutes, fan cycling will be on continuously. Change the setting to a lower amount if this is not desired.

The ventilation damper does not open when the HVAC fan is active.

- The damper will not open if the Cycle Time within the current period has already been met. For instance if the Cycle Time is set to 5 minutes and the control has already ventilated for 5 minutes in that interval, the damper will remain closed.
- If using the Outdoor Temperature Sensor, check that it is installed in the Outdoor Air Intake a maximum of 3 feet from the outside wall, or on the North, East or West side of the house. (Not in direct sunlight.) If the outdoor temperature is below 0°F or above 100°F, the damper will remain closed.
- If using the outdoor temperature sensor, verify that it is reporting an accurate resistance. Remove the Outdoor Temperature Sensor leads from ODT Sensor terminals and check the resistance. Compare the reading with the resistance shown in **Table 4**.

Outdoor Temperature	Resistance
-30°F	229,500 OHMS
-20°F	162,500 OHMS
-10°F	116,500 OHMS
0°F	84,500 OHMS
10°F	62,000 OHMS
20°F	46,000 OHMS
30°F	34,500 OHMS
40°F	26,000 OHMS
50°F	20,000 OHMS
60°F	15,500 OHMS
70°F	12,000 OHMS
80°F	9,500 OHMS
90°F	7,500 OHMS
100°F	6,000 OHMS

The HVAC fan turns on unexpectedly.

- The control will turn on the fan as needed to meet the air cycling requirements determined by the Cycle Time and Cycle Period settings.

The dehumidifier does not run.

- Follow all of the system checkout procedures.
- Check that the power switch on the dehumidifier is on.
- Check that the circuit breaker is not tripped. The dehumidifier requires a minimum of 8 amps. The dehumidifier should be placed on a dedicated 15 amp circuit or a lightly loaded circuit.

The compressor never runs.

- If a float switch is not installed, confirm that the jumper is installed at the float switch terminals on the control board.
- If a float switch is installed, confirm that the float switch is not open.

## DEHUMIDIFIER SEQUENCE OF OPERATION

IF THE DEHUMIDIFIER IS NOT WIRED TO THE HVAC EQUIPMENT, THE DEHUMIDIFIER WILL SAMPLE AT THE END OF THE CYCLE PERIOD.

With 4 minutes left in the Cycle Period, the dehumidifier will turn on the dehumidifier blower for 3 minutes. During this time the temperature and relative humidity are measured and the dewpoint is calculated. If the dewpoint is higher than the setting at the Control Knob then the dehumidifier compressor will turn on and the dehumidifier will run until it reaches set point.

After reaching the set point, the dehumidifier will not sample again until the end of the next Sample Period.

For example, if the Sample Period is set for 1 hour, the dehumidifier will sample at the end of the hour. Once the dehumidifier reaches set point and shuts off, the dehumidifier will not sample again until the end of the next hour.

IF THE DEHUMIDIFIER IS WIRED INTO THE HVAC EQUIPMENT, THE DEHUMIDIFIER WILL SAMPLE THE FIRST TIME THE HVAC EQUIPMENT RUNS IN THE CYCLE PERIOD OR AT THE END OF THE CYCLE PERIOD IF THE HVAC EQUIPMENT DOES NOT RUN.

For example, if the Cycle Period is set to 1 hour and the air conditioner starts 15 minutes into that hour, the dehumidifier will sample when the air conditioner starts. Once the dehumidifier begins dehumidifying, it will run until set point is reached. If the dehumidifier samples and determines that dehumidification is not needed, it will not sample again until the next Cycle Period.

## DAMPER SEQUENCE OF OPERATION

In the Central/Zoned installation 4 motorized dampers are used to control the airflow through the dehumidifier. The dampers are energized when the HVAC equipment is running. This means that when the HVAC equipment is running, the dampers are in the central position. When the HVAC equipment is not running, the dampers are in the zoned position.

## VENTILATION OR AIR CYCLING SEQUENCE OF OPERATION

If the dehumidifier is providing outdoor air ventilation or air cycling, it is monitoring the HVAC equipment to provide the amount of HVAC fan run time that has been set by the Cycle Time during the Cycle Period.

If an outdoor air damper has not been installed then the dehumidifier is providing air cycling. The dehumidifier will monitor the HVAC system and if the system has not run for the specified Cycle Time within the Cycle Period, the dehumidifier will energize the HVAC fan through the G terminal to provide the desired amount of fan run time.

For example, if the Cycle Time is set for 10 minutes and the Cycle Period is set for 1 hour then the dehumidifier will provide 10 minutes of air cycling or outdoor air ventilation. If the HVAC system runs for 5 minutes during this hour then the dehumidifier will energize the fan for an additional 5 minutes.

If an outdoor air damper has been installed, then the Aprilaire dehumidifier is providing outdoor air ventilation. The dehumidifier will open the outdoor air damper whenever the HVAC system is running, up to the amount of time specified by the Cycle Time. The dehumidifier will energize the HVAC fan and open the outdoor air damper to provide the desired ventilation time if the HVAC system has not run for the specified Cycle Time. During ventilation, the dehumidifier blower will operate and the unit will dehumidify if necessary.

If an Outdoor Temperature Sensor has been installed, then the dehumidifier will use the outdoor temperature to determine if the outdoor air damper is to be opened. If the outdoor temperature is above 100°F the damper will not open. If the temperature is between 20°F and 0°F the damper will only open with a heat call. If the outdoor temperature is below 0°F, the damper will not open. If the Outdoor Temperature Sensor is not installed then the temperature is not considered in opening the damper.